



studio
drvodom d.o.o.



OKOV



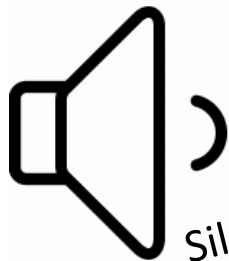

studio
drvodom d.o.o.

SEVROLL GEMINI OKOV

GEMINI 4mm

- Okov za 4mm ispunu skaklo/ogledalo
- PAX ručnica
- Donja/gornja horizontala
- Jednostavna montaža
- DOŽIVOTNA GARANCIJA NA TOČKICE
- H profil 44mm pogodan za lijepljenje i ojačavanje stakla
- Lijevi, desni i srednji ublazivač
- „nevidljivi” okov za staklo/ogledalo
- Mogućnost rezanja na mjeru i slanja mjera ispune prema kupcu

GEMINI 10mm

- Okov za 10mm ispunu
- JULIJA i FOX ručnica
- Donja/gornja horizontala
- Jednostavna montaža
- DOŽIVOTNA GARANCIJA NA TOČKICE
- H profil 10mm pogodan spajanje više dijelova ispune
- Lijevi, desni i srednji ublazivač
- Jednostavna montaža stakla bez i sa ispunom
- Mogućnost rezanja na mjeru i slanja mjera ispune prema kupcu

GEMINI 18mm

- Okov za 18mm ispunu
- ALFA, FOCUS i FAWORYT ručnica
- Ukopni točkići sto pruža optimalnu nosivost na točkić
- Jednostavna montaža
- DOŽIVOTNA GARANCIJA NA TOČKICE
- H profil 18mm pogodan spajanje više dijelova ispune
- Lijevi, desni i srednji ublazivač
- Jednostavna montaža stakla bez i sa ispunom
- Okov u BIJELOJ BOJI
- Mogućnost rezanja na mjeru i slanja mjera ispune prema kupcu



SEVROLL BLUE OKOV

ERA ram

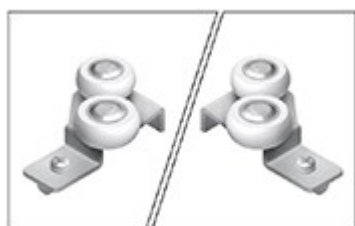
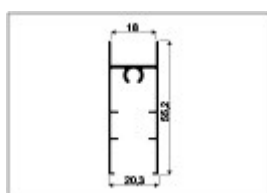
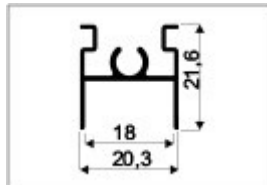

ERA ispuna



BLUE 18mm

- Okov za 18mm ispunu
- ERA ručkica
- Donja/gornja horizontala
- Montaža ispuna bez horizontali
- Jednostavna montaža
- H profil 18mm pogodan spajanje više dijelova ispune
- Lijevi, desni i srednji ublazivač
- Jednostavna montaža stakla bez i sa ispunom
- Mogućnost rezanja na mjeru i slanja mjera ispune prema kupcu
- Moguća kombinacija sa GEMINI točkicama, gornjoj/donjoj vodilici

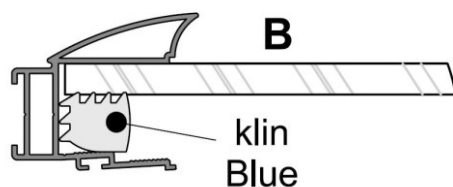
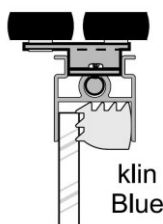



studio
drvodom d.o.o.

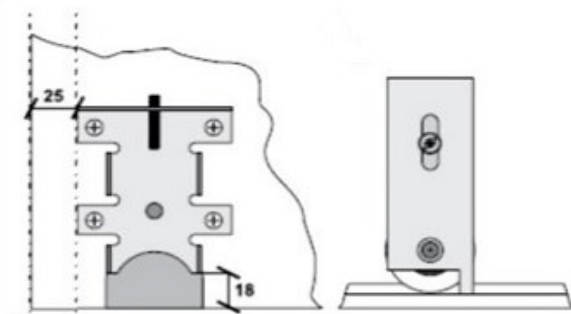
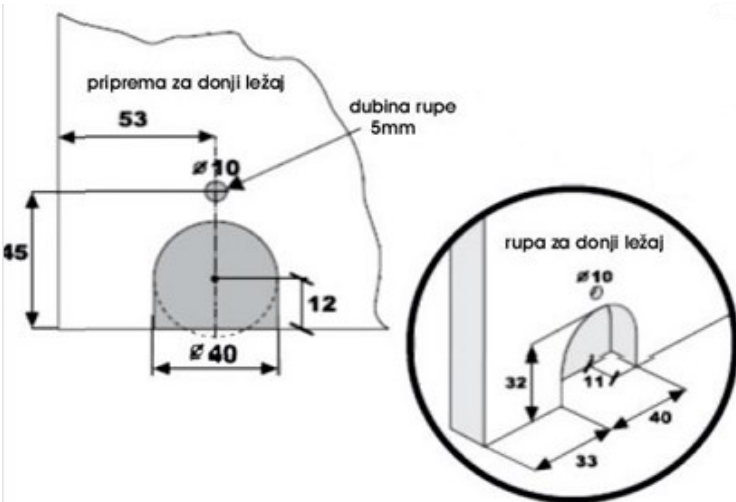
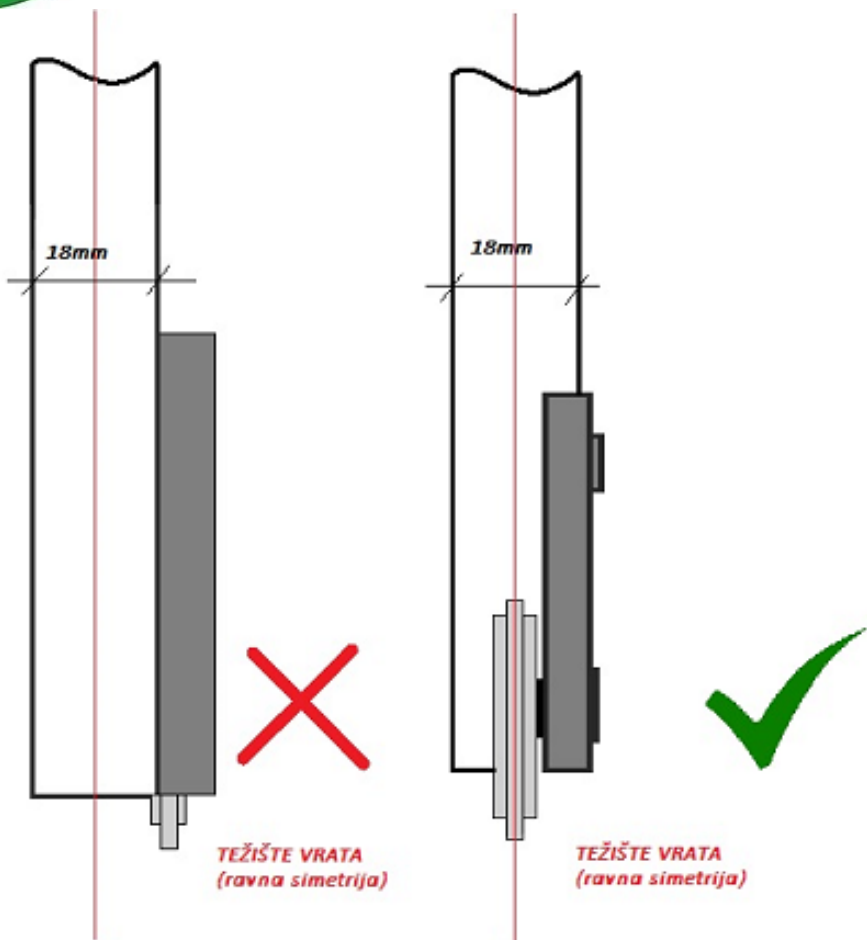

VAŽNO!
Pri montaži obratite pažnju da ose K i L budu paralelne! (K || L)

GEMINI 4



- idealno rješenje za staklo ili ogledalo ispune
- okvir za ispune 4mm (vidljivost okvira po 2 mm oko ispune)
- MAX nosivost 50KG
- podesivo po visini ± 7 mm, nagib $\pm 5^\circ$
- MAX dužina vodilice 6m
- moguća ugradnja ublaživača na krajnja kao i srednja vrata
- široka bočna četkica pokriva vijke za spajanje

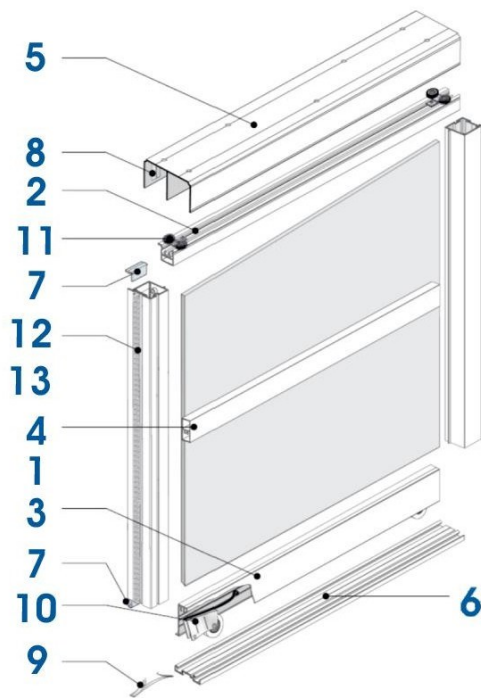

šifra	naziv	JM
SVGRPAX	Sevroll G4 ručnica PAX 2700 ALU	KOM

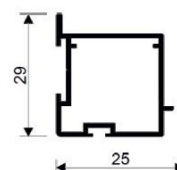

šifra	naziv	JM
SVGGH4	Sevroll G4 gonja horizontala 3000 ALU	KOM

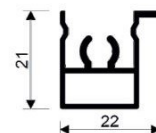

šifra	naziv	JM
SVGDH4	Sevroll G4 donja horizontala 3000 ALU	KOM

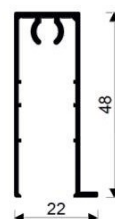

šifra	naziv	JM
SVGHP4	Sevroll G4 H profil 3000 ALU	KOM

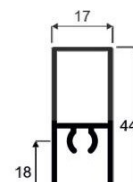



GEMINI 4

SEVROLL

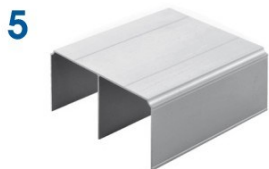

šifra	naziv	JM
SVGGV	Sevroll G4-10-18 gornja vodilica 6000 ALU	KOM

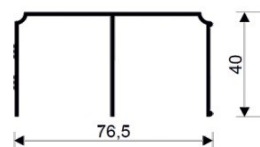

šifra	naziv	JM
SVGDV	Sevroll G4-10-18 donja vodilica 6000 ALU	KOM

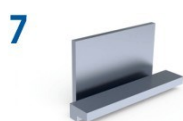
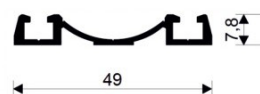

šifra	naziv	JM
SVGZRPAX	Sevroll G4 završetak ručkice PAX 1kpl=4kom	KPL



šifra	naziv	JM
SVGGPS	Sevroll G4-10-18 gornji PVC stoper	KOM

šifra	naziv	JM
SVGUB	Sevroll G4-10-18 ublaživač bočni L-D40KG	KPL



šifra	naziv	JM
SVGDMS	Sevroll G4-10-18 donji metalni stoper	KOM



šifra	naziv	JM
SVGDL1SET	Sevroll G4-10 donji ležaj 1 FOX-JULIA-PAX (1par-2kom)	PAR

PREPORUKA:
visinu vrata dodatno umanjiti za 2 mm!

šifra	naziv	JM
SVGUS	Sevroll G4-10-18 ublaživač srednji 40KG	KPL



šifra	naziv	JM
SVGGL2	Sevroll G4-10 gornji ležaj 2 JULIA-PAX	KOM



šifra	naziv	JM
SVGV	Sevroll G4-10 vijak za spajanje	KOM
SVGŠČ	Sevroll G4-10-18 spajalica četkice	KOM

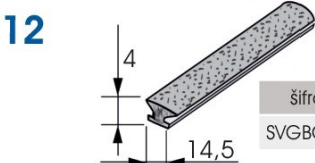

šifra	naziv	JM
SVGBČU1	Sevroll G4-10 bočna četkica uvlačenje 1 FOX-JULIA-PAX	M

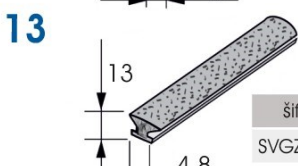

šifra	naziv	JM
SVGZČU	Sevroll G4-10 zadnja četkica uvlačenje FOX-PAX 4,8x13	M

GEMINI 4

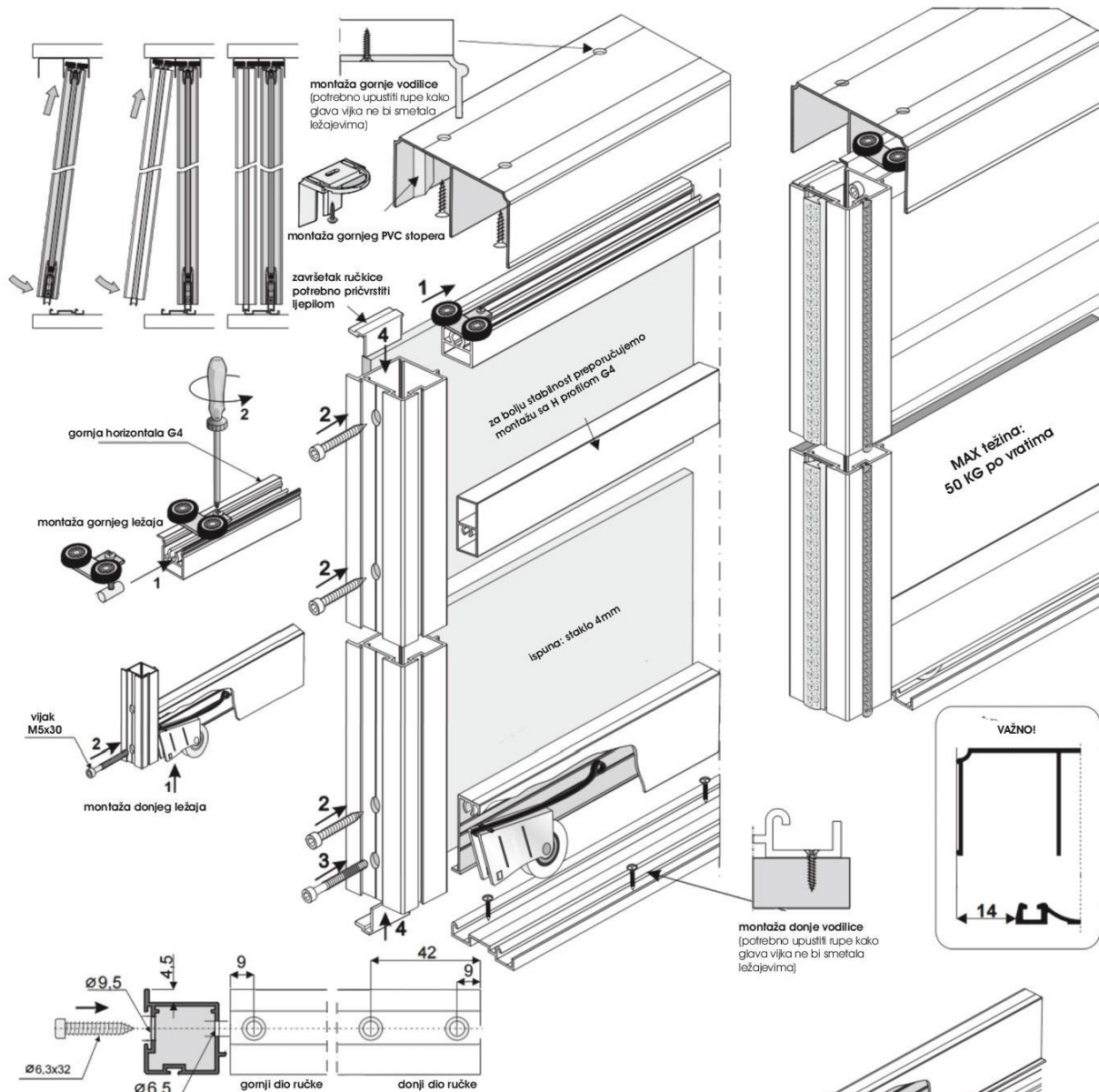

KOMPONENTE

<p>ručnica PAX</p> <p>čelika zadnja</p> <p>čelika bočna</p>	<p>gornja vodilica</p> <p>76 mm</p>	<p>donja vodilica</p> <p>49mm</p>	<p>završetak za ručnicu PAX</p> <p>4x</p>
<p>gornji ležaj</p>	<p>A donja horizontala</p> <p>B gornja horizontala</p>	<p>donji ležaj</p>	<p>ukrutni H profil PAX</p>

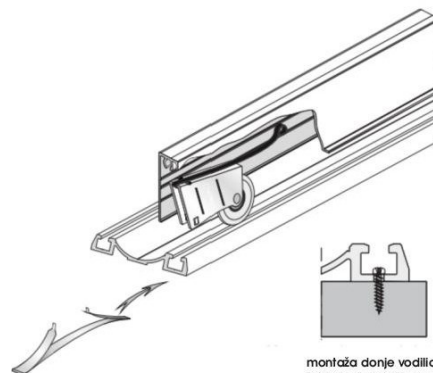

GEMINI 4

dimezije svijetlog otvora

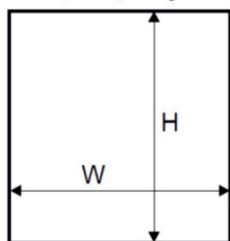

ispuna:
-ogledalo/staklo 4mm

dužina ručkice = visina vrata

visina vrata - h $h = H - 40 \text{ mm}$

visina ispune (mirror)	- hm	$hm = h - 4 \text{ mm}$
širina vrata	- w	$w = (W - 3 + Z) : N$
širina ispune (mirror)	- wm	$wm = w - 4 \text{ mm}$
dužina donje horizontale	- L	$L = U = w - 50 \text{ mm}$
dužina gornje horizontale	- U	

broj vrata	- N	2	3
ukupno preklopa	- Z	25 mm	50 mm

primjer izračuna različitih preklapanja:	
	$w = (W + 72) : 4$
	$w = (W : 2 + 22) : 2$

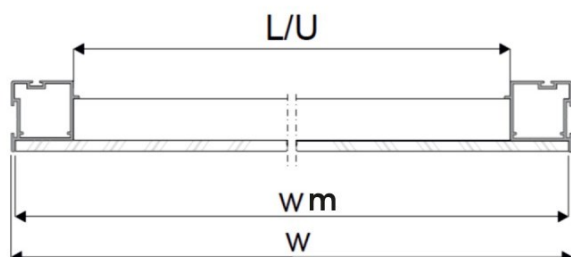

postupak montaže:

ručkica PAX



gornja horizontala

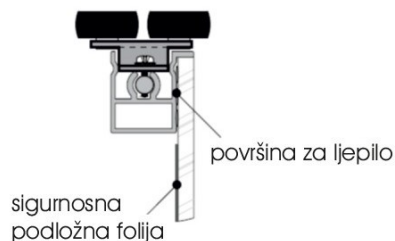

donja horizontala

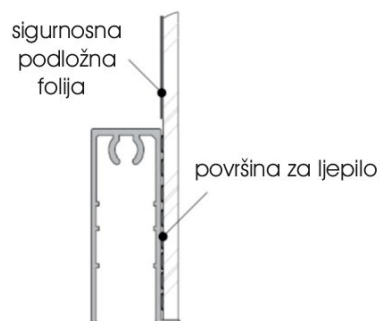

Preporučljivo je da ogledalo / staklo budu zalijepljeni na aluminijski profil sa adekvatnim ljeplilom!

PAŽNJA

Stražnja površina ogledala / stakla treba biti osigurana sa sigurnosnom folijom. Rubovi stakla moraju biti polirani.



GEMINI 10



- idealno rješenje za kombiniranje raličitih ispune 10 ili 4mm (iveral, staklo, ogledalo,...)
- MAX nosivost 50KG
- podesivo po visini ± 7 mm, nagib $\pm 5^\circ$
- MAX dužina vodilice 6m
- moguća ugradnja ublaživača na krajnja kao i srednja vrata
- široka bočna četkica pokriva vijke za spajanje

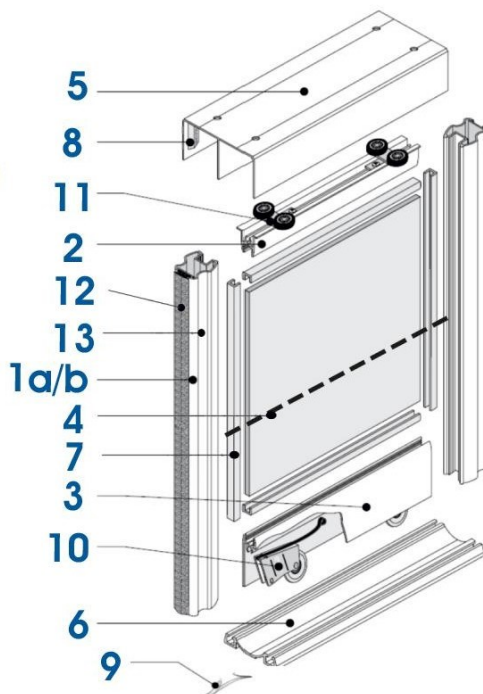

1a



šifra	naziv	JM
SVGRFOX	Sevroll G10 ručica FOX 2700 ALU	KOM

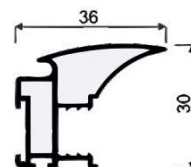

1b



šifra	naziv	JM
SVGRJULIA	Sevroll G10 ručica JULIA 2700 ALU	KOM



2



šifra	naziv	JM
SVGGH10	Sevroll G10 gornja horizontala 3000 ALU	KOM

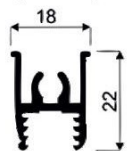

3



šifra	naziv	JM
SVGDH10	Sevroll G10 donja horizontala 3000 ALU	KOM

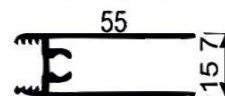

4



šifra	naziv	JM
SVGHP10	Sevroll G10 H profil 3000 ALU	KOM

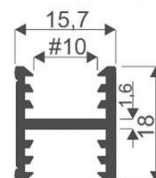



GEMINI 10

SEVROLL

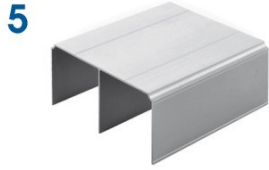

šifra	naziv	JM
SVGGV	Sevroll G4-10-18 gornja vodilica 6000 ALU	KOM

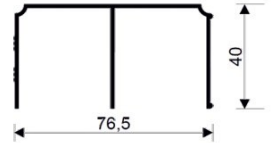

šifra	naziv	JM
SVGDV	Sevroll G4-10-18 donja vodilica 6000 ALU	KOM

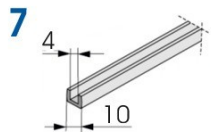
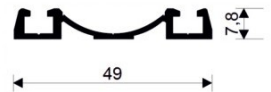

šifra	naziv	JM
SVGUPS	Sevroll G10 U profil za staklo 4mm transp.	M



šifra	naziv	JM
SVGGPS	Sevroll G4-10-18 gornji PVC stoper	KOM

šifra	naziv	JM
SVGUB	Sevroll G4-10-18 ublaživač bočni L-D40KG	KPL



šifra	naziv	JM
SVGDMS	Sevroll G4-10-18 donji metalni stoper	KOM



šifra	naziv	JM
SVGDL1SET	Sevroll G4-10 donji ležaj 1 FOX-JULIA-PAX (1par-2kom)	PAR

PREPORUKA:
visinu vrata dodatno umanjiti za 2 mm!

šifra	naziv	JM
SVGUS	Sevroll G4-10-18 ublaživač srednji 40KG	KPL



šifra	naziv	JM
SVGGL1	Sevroll G10 gornji ležaj 1 FOX	KOM
SVGGL2	Sevroll G4-10 gornji ležaj 2 JULIA-PAX	KOM



šifra	naziv	JM
SVGJ	Sevroll G4-10 vijak za spajanje	KOM
SVGŠČ	Sevroll G4-10-18 spajalica četkice	KOM

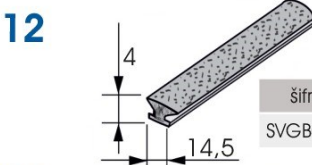

šifra	naziv	JM
SVGBČU1	Sevroll G4-10 bočna četkica uvlačenje 1 FOX-JULIA-PAX	M

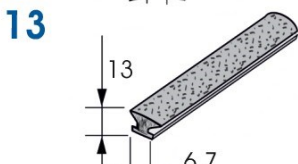

šifra	naziv	JM
SVGZČU	Sevroll G4-10 zadnja četkica uvlačenje FOX-PAX 4,8x13	M
SVGZČLJ	Sevroll G10-18 zadnja četkica ljepljenje JULIA-ALFA-FAWORTY-FOCUS 6,7x13	M

GEMINI 10 FOX

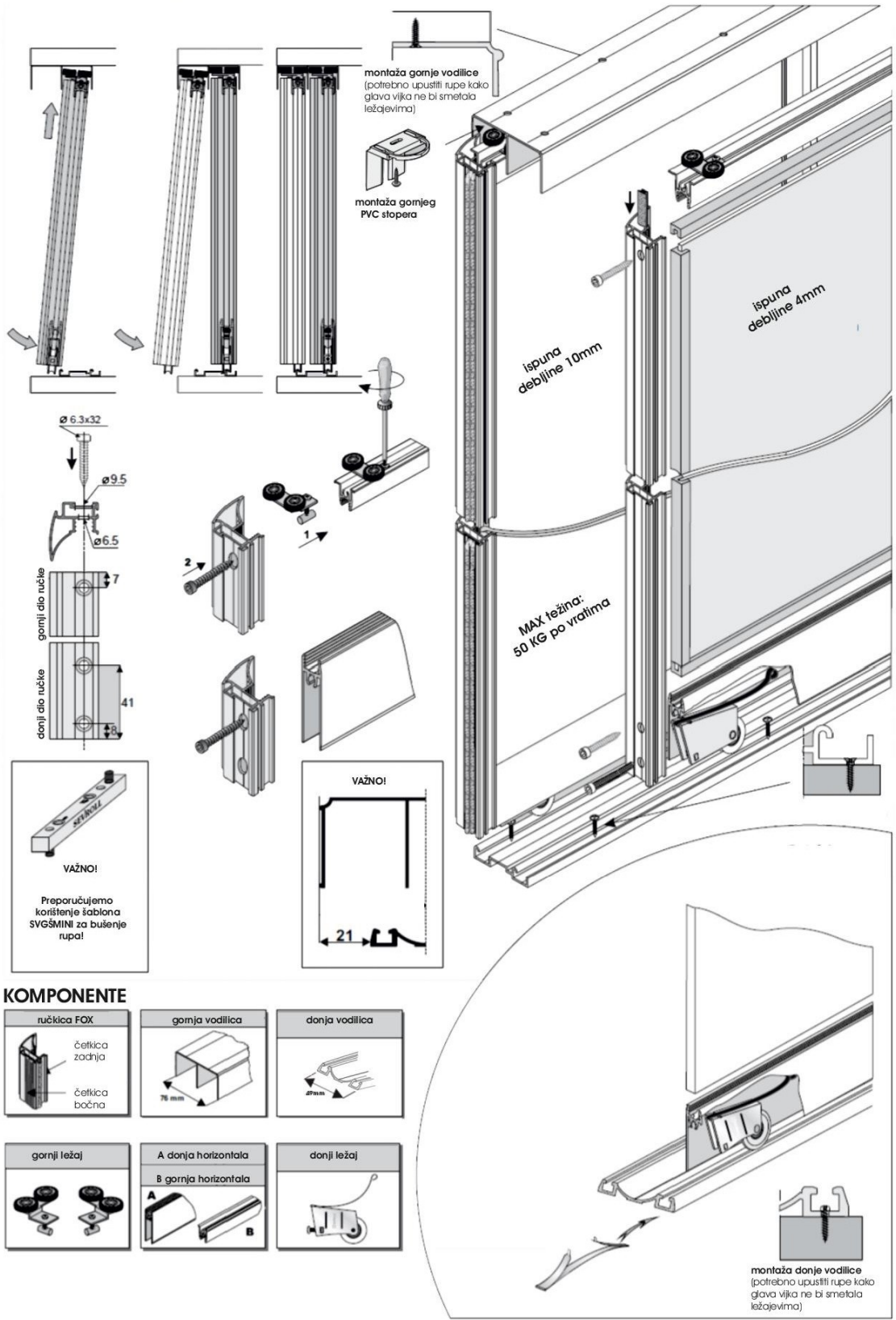

ispuna
debljine 10mm

ispuna
debljine 4mm

MAX težina:
50 KG po vratima

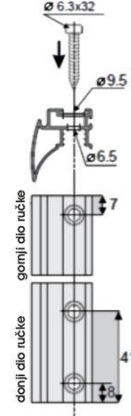

Preporučujemo
korištenje šablona
SVGŠMINI za bušenje
rupa!

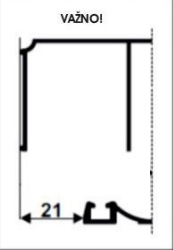

KOMPONENTE

<p>ručica FOX</p> <p>četkica zadnja četkica bočna</p>	<p>gornja vodilica</p> <p>76 mm</p>	<p>donja vodilica</p> <p>76 mm</p>
<p>gornji ležaj</p>	<p>A donja horizontala B gornja horizontala</p>	<p>donji ležaj</p>

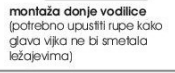

GEMINI 10 FOX

SEVROLL

dimezije svijetlog otvora

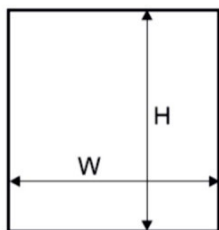

ispuna:
-ploča debljive 10mm
-ogledalo/staklo 4mm

dužina ručkice = visina vrata

visina vrata - h h = H - 40 mm

visina ispune (board) - hb	hb = h - 64 mm
širina vrata - w	w = (W - 3 + Z) : N
širina ispune (board) - wb	wb = w - 20 mm
dužina donje horizontale - L dužina gornje horizontale - U	L = U = w - 37 mm
visina ogledala (mirror) - hm	hm = hb
širina ogledala (mirror) - wm	wm = wb - 4 mm

broj vrata - N	2	3
ukupno preklapa - Z	36 mm	72 mm

primjer izračuna različitih preklapanja:	
	w = (W + 105) : 4
	w = (W : 2 + 33) : 2

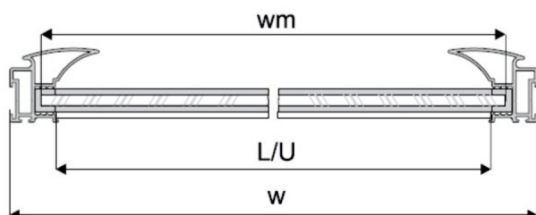
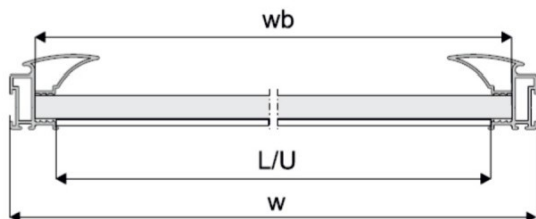

postupak montaže:

ručkica FOX

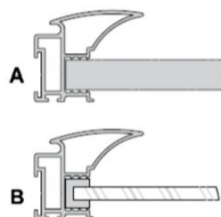

gornja horizontala

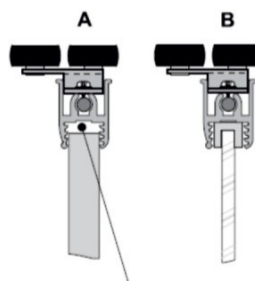

slobodni prostor uključen u izračunu

donja horizontala

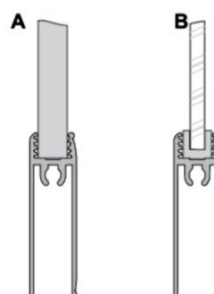

PAŽNJA

Stražnja površina ogledala / stakla treba biti osigurana sa sigurnosnom folijom.

GEMINI 10 JULIA

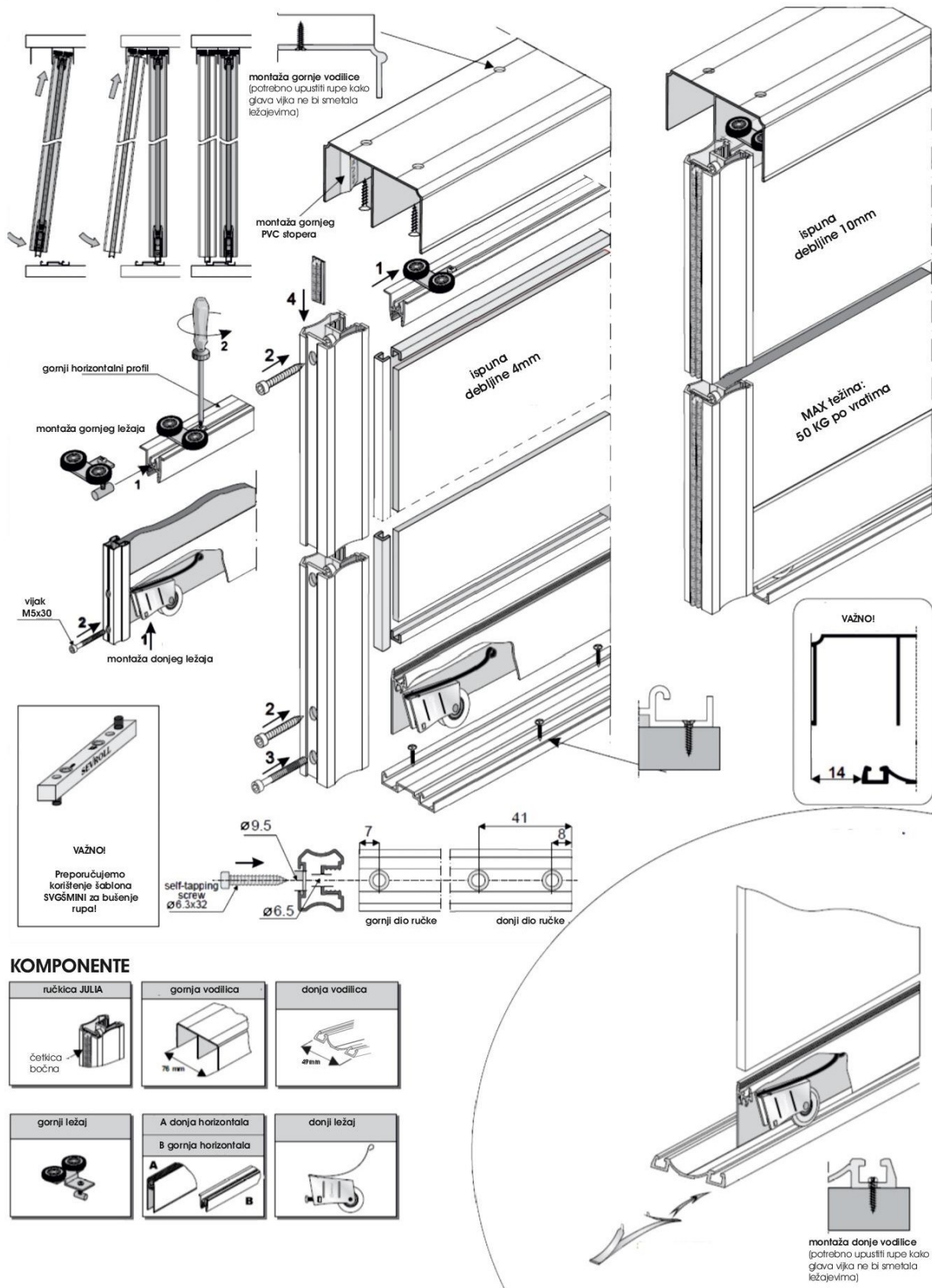

KOMPONENTE

<p>ručkica JULIA</p> <p>četkica bočna</p>	<p>gornja vodilica</p>	<p>donja vodilica</p>
<p>gornji ležaj</p>	<p>A donja horizontala B gornja horizontala</p>	<p>donji ležaj</p>



GEMINI 10 JULIA

dimezije svijetlog otvora

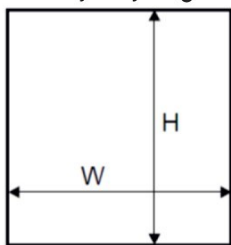

ispuna:
-ploča debljive 10mm
-ogledalo/staklo 4mm

dužina ručkice = visina vrata

visina vrata - h $h = H - 40$ mm

visina ispune (board) - hb	$hb = h - 64$ mm
širina vrata - w	$w = (W - 3 + Z) : N$
širina ispune (board) - wb	$wb = w - 25$ mm
dužina donje horizontale - L dužina gornje horizontale - U	$L = U = w - 42$ mm

broj vrata - N	2	3
ukupno preklopa - Z	22 mm	44 mm

primjer izračuna različitih preklapanja:

	$w = (W + 63) : 4$
	$w = (W : 2 + 19) : 2$

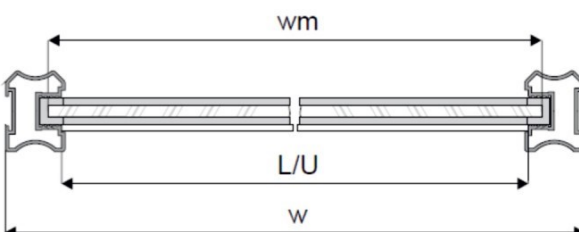
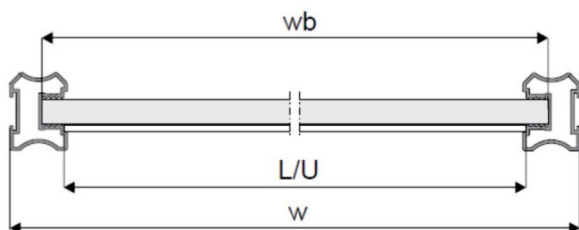

postupak montaže:

ručkica JULIA

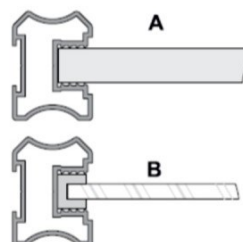

gornja horizontala

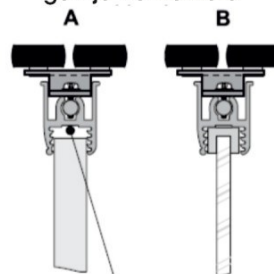

slobodni prostor uključen u izračunu

donja horizontala

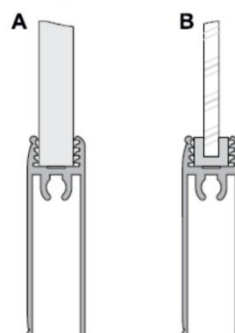

za ispunu debljine 4mm:

visina ogledala - hm	$hm = hb$
širina ogledala - wm	$wm = wb - 4$ mm

PAŽNJA

Stražnja površina ogledala / stakla treba biti osigurana sa sigurnosnom folijom.

GEMINI 18



- idealno rješenje za ispune 18mm bez okvira
- MAX nosivost 50KG
- podesivo po visini ± 7 mm, nagib $\pm 5^\circ$
- MAX dužina vodilice 6m
- moguća ugradnja ublaživača na krajnja kao i srednja vrata

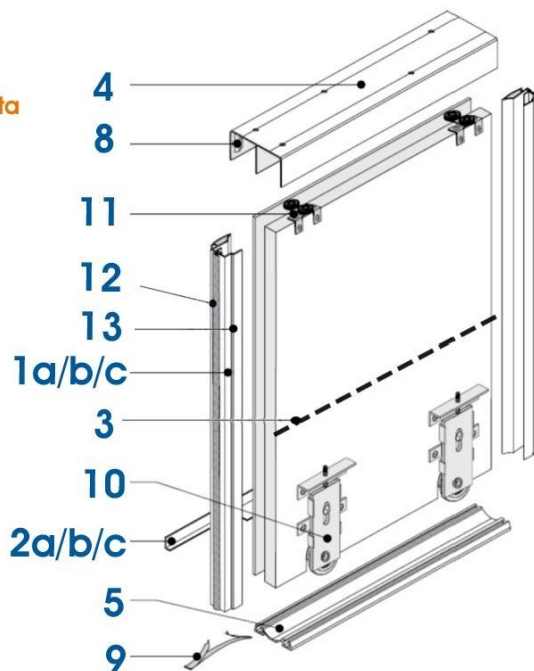

1a



šifra	naziv	JM
SVGRALFA	Sevroll G18 ručica ALFA 2700 ALU	KOM

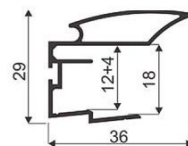

1b



šifra	naziv	JM
SVGRFAWORTY	Sevroll G18 ručica JFAWORTY 2700 ALU	KOM



1c



šifra	naziv	JM
SVGFOCUS	Sevroll G18 ručica FOCUS 2700 ALU	KOM

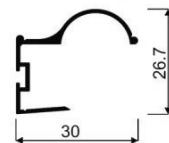

2a



šifra	naziv	JM
SVGLP18	Sevroll G18 L profil 3000 ALU	KOM

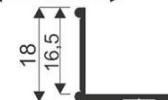

2b



šifra	naziv	JM
SVGLPM18	Sevroll G18 L profil MINI 3000 ALU	KOM

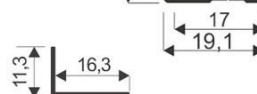

2c



šifra	naziv	JM
SVGUP18	Sevroll G18 U profil 3000 ALU	KOM





GEMINI 18

SEVROLL



šifra	naziv	JM
SVGHP18	Sevroll G18 H profil 3000 ALU	KOM

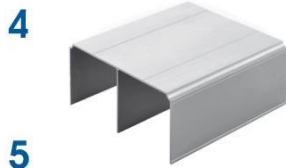
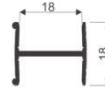

šifra	naziv	JM
SVGGV	Sevroll G4-10-18 gornja vodilica 6000 ALU	KOM

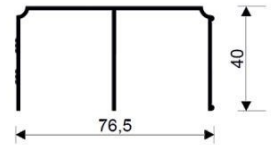

šifra	naziv	JM
SGVDV	Sevroll G4-10-18 donja vodilica 6000 ALU	KOM

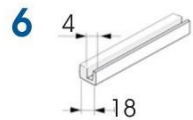
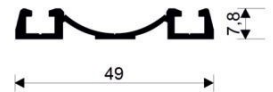

šifra	naziv	JM
SVGUPSN	Sevroll G18 U profil za staklo 4mmnesimetrični	M
SVGUZS	Sevroll G18 umetak za staklo 4mm 14x40	KOM



šifra	naziv	JM
SVGGPS	Sevroll G4-10-18 gornji PVC stoper	KOM



šifra	naziv	JM
SGVDMS	Sevroll G4-10-18 donji metalni stoper	KOM

šifra	naziv	JM
SVGUB	Sevroll G4-10-18 ublaživač bočni L-D40KG	KPL



šifra	naziv	JM
SVGDL2SET	Sevroll G18 donji ležaj 2 ALFA-FAWORTY-FOCUS (1 par-2kom) PAR	



PREPORUKA:
visinu vrata dodatno umanjiti za 2 mm!



šifra	naziv	JM
SVGGL3	Sevroll G18 gornji ležaj 3 ALFA-FAWORTY-FOCUS PAR	

šifra	naziv	JM
SVGUS	Sevroll G4-10-18 ublaživač srednji 40KG	KPL

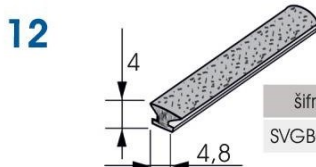

šifra	naziv	JM
SVGBČU2	Sevroll G18 bočna četkica uvlačenje 2 ALFA-FAWORTY-FOCUS	M

šifra	naziv	JM
SVGŠČ	Sevroll G4-10-18 spajalica četkice	KOM

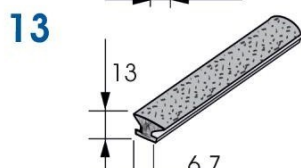

šifra	naziv	JM
SVGŽČLJ	Sevroll G10-18 zadnja četkica ljepljenje JULIA-ALFA-FAWORTY-FOCUS 6,7x13	M

GEMINI 18 ALFA

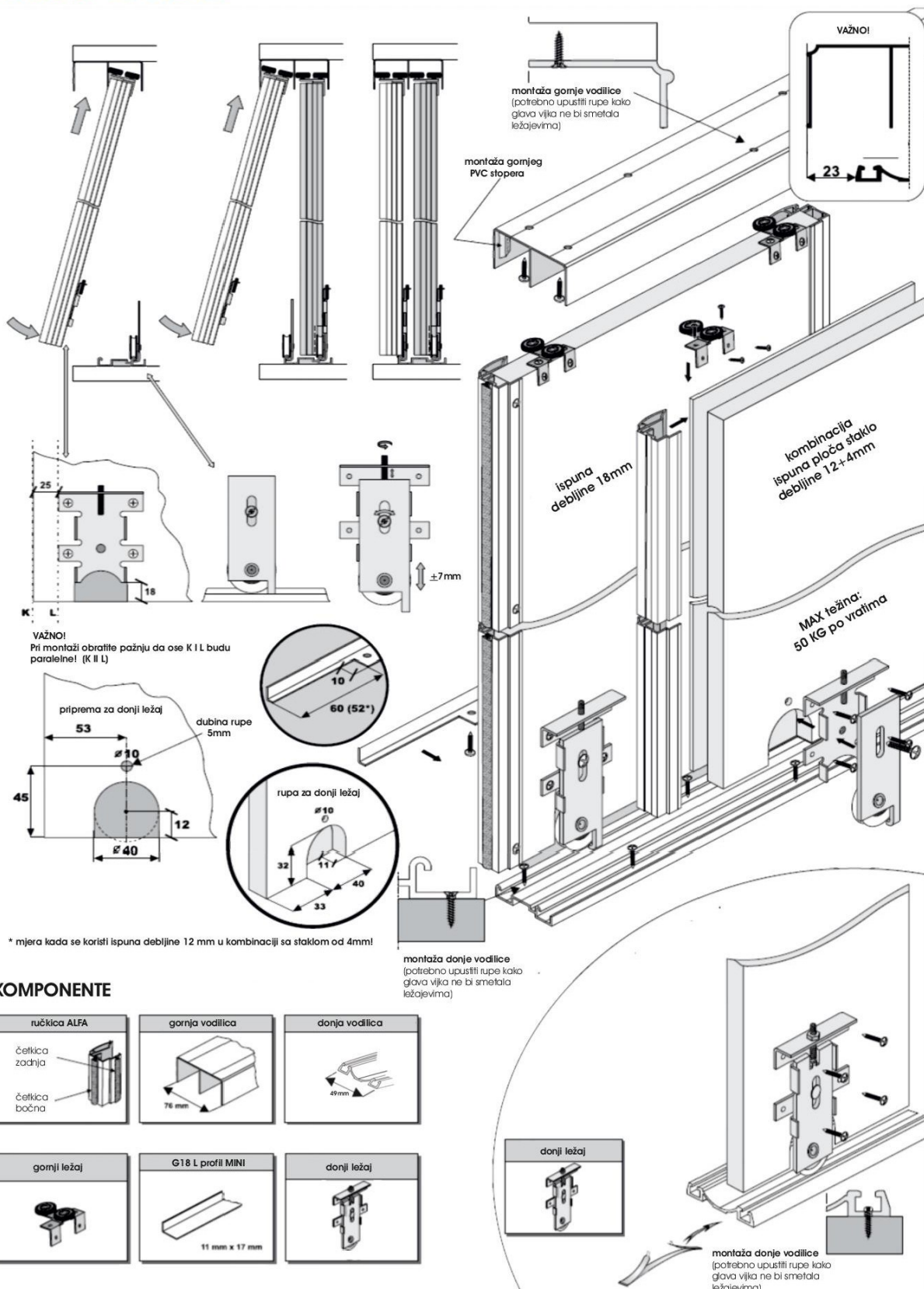

KOMPONENTE

<p>ručica ALFA</p> <p>četkica zadnja</p> <p>četkica bočna</p>	<p>gornja vodilica</p> <p>76 mm</p>	<p>donja vodilica</p> <p>49 mm</p>
<p>gornji ležaj</p>	<p>G18 L profil MINI</p> <p>11 mm x 17 mm</p>	<p>donji ležaj</p>



GEMINI 18 ALFA

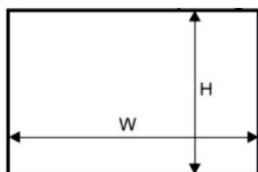

dimenzije svijetlog otvora

ispuna:
-ploča debljive 10mm
-ogledalo/staklo 4mm

dužina ručkice = visina vrata

visina vrata	- h	$h = H - 42 \text{ mm}$
visina ispune (board)	- hb	$hb = h - 2^* \text{ mm}$
širina vrata	- w	$w = (W - 3 + Z) : N$
širina ispune #18	- wb	$wb = w - 22 \text{ mm}$
širina ispune #12	- wb _m	$wb_m = w - 7 \text{ mm}$
dužina horizontala (L profil)- la		$la = w - 50 \text{ mm}$

*ako koristimo donji "L" profil

broj vrata	- N	2	3
ukupno preklopa	- Z	36 mm	72 mm

primjer izračuna različutih preklapanja:	
	$w = (W + 105) : 4$
	$w = (W : 2 + 33) : 2$

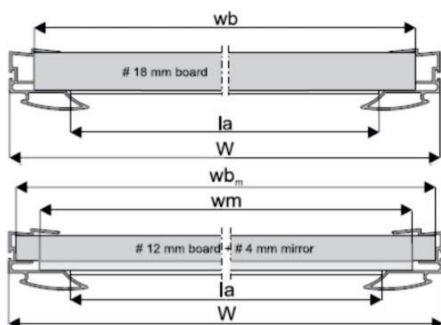

dimenzije ogledala:

visina/mirror - hm = hb - 4 mm
širina/mirror - wm = wb_m - 20 mm

Oprez:
Prije ljepljenja očistiti površine!

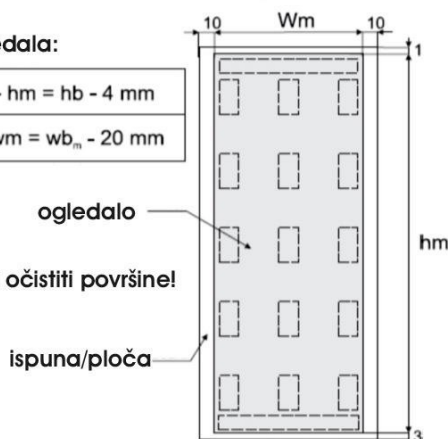

Ucrтана polja označavaju mjesto obostrano-ljepljive trake!

SEVROLL

postupak montaže:

ručnica ALFA (ispuna 18mm)



ručnica ALFA (ispuna 12+4mm)

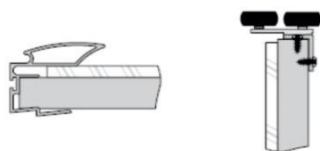

montaža "L" profila MINI

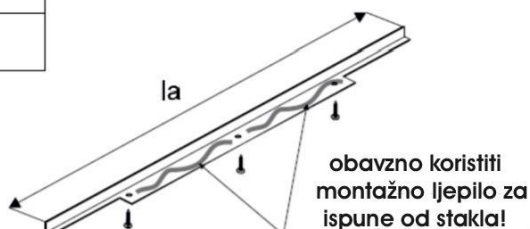

Oprez:
L profil pričvrstiti sa najmanje 3 vijka 3x25!

PAŽNJA

Ručnica treba biti duža od visine ispune za 2 mm!

VAŽNO

Sevroll ne preuzima odgovornost za deformacije vrata, koje uzrokuje pogrešna montaža ili nekvalitetna ispuna!

GEMINI 18 FAWORTY

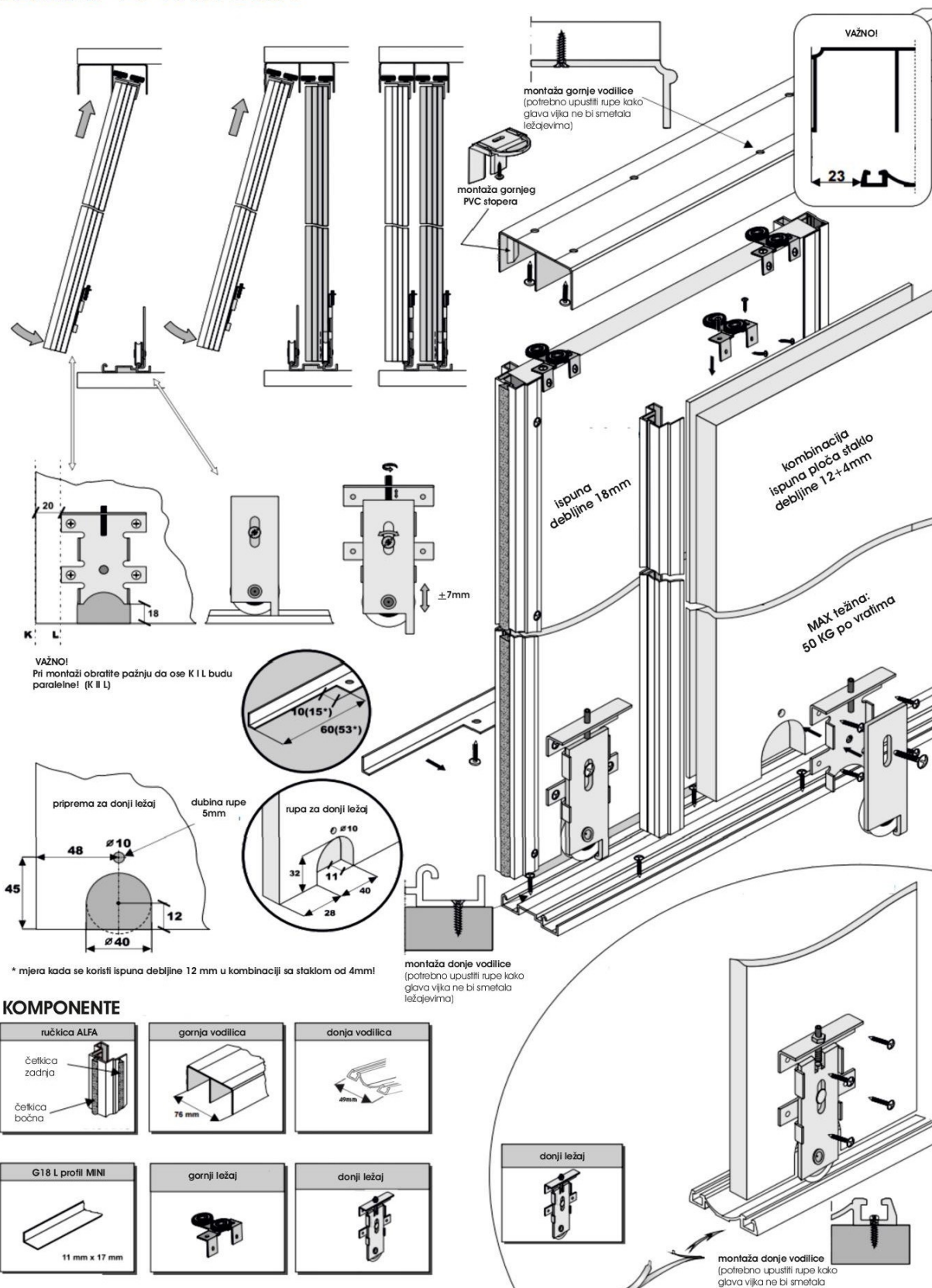

GEMINI 18 FAWORTY

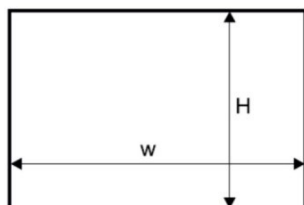

dimezije svijetlog otvora

ispuna:
-ploča debljine 10mm
-ogledalo/staklo 4mm

dužina ručkice = visina vrata

visina vrata	- h	$h = H - 42 \text{ mm}$
visina ispune (board)	- hb	$hb = h - 2^* \text{ mm}$
širina vrata	- w	$w = (W - 3 + Z) : N$
širina ispune #18	- wb	$wb = w - 19 \text{ mm}$
širina ispune #12	- wb _L	$wb_L = w - 7 \text{ mm}$
dužina horizontala (L profil)- la		$la = w - 34 \text{ mm}$

*ako koristimo donji "L" profil

broj vrata	- N	2	3
ukupno preklopa	- Z	18 mm	36 mm

primjer izračuna različitih preklopanja:

	$w = (W + 51) : 4$
	$w = (W : 2 + 15) : 2$

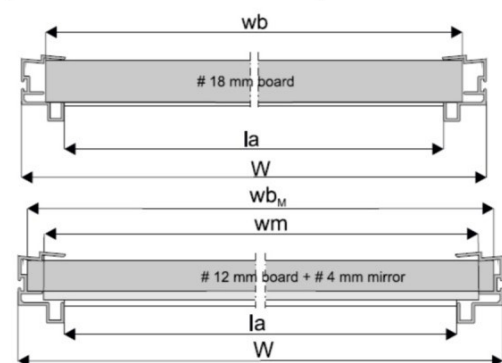

dimezije ogledala:

visina/mirror- $hm = hb - 4 \text{ mm}$

širina/mirror- $wm = wb_L - 16 \text{ mm}$

ogledalo

Oprez:

Prije ljepljenja očistiti površine!

ispuna/ploča

Ucrтана polja označavaju

mjesto obaranja "ogledala" i "ispune"

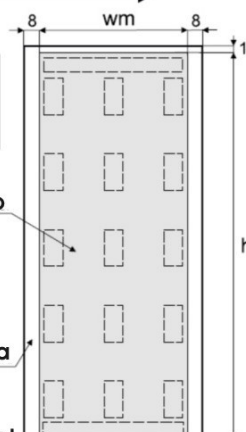

postupak montaže:

ručnica FAWORTY (ispuna 18mm)



ručnica FAWORTY (ispuna 12+4mm)

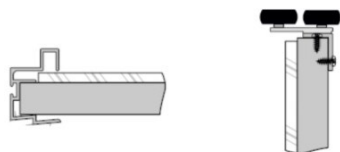

montaža "L" profila MINI

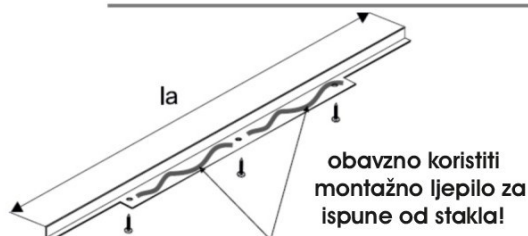
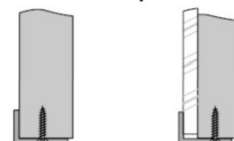

Oprez:

L profil pričvrstiti sa najmanje 3 vijka 3x25!

PAŽNJA

Ručnica treba biti duža od visine ispune za 2 mm!

VAŽNO

Sevroll ne preuzima odgovornost za deformacije vrata, koje uzrokuje pogrešna montaža ili nekvalitetna ispuna!

GEMINI 18 FOCUS

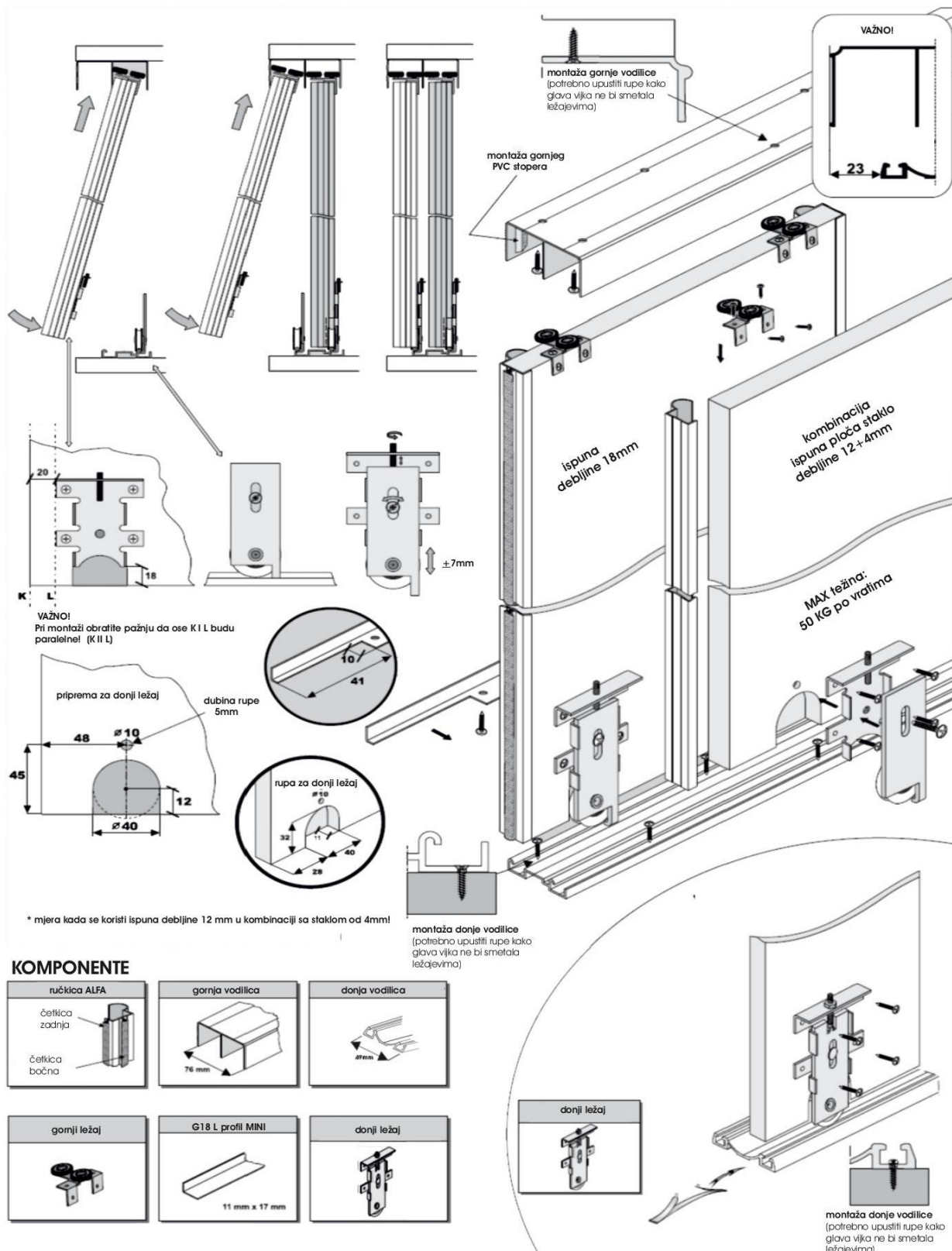



GEMINI 18 FOCUS

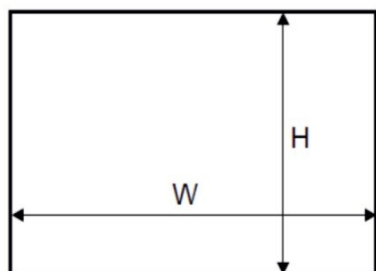

dimezije svijetlog otvora

ispuna:
-ploča debljive 18mm

dužina ručkice = visina vrata

visina vrata	- h	$h = H - 42 \text{ mm}$
visina ispune (board)	- hb	$hb = h - 2^* \text{ mm}$
širina vrata	- w	$w = (W - 3 + Z) : N$
širina ispune (board)	- wb	$wb = w - 7 \text{ mm}$
dužina horizontala (L profil)	- la	$la = w - 56 \text{ mm}$

*ako koristimo donji "L" profil

postupak montaže:

ručnica FOCUS

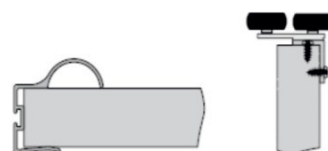

montaža "L" profila MINI



broj vrata	- N	2	3
ukupno preklopa	- Z	29 mm	58 mm

primjer izračuna različitih preklapanja:

	$w = (W + 84) : 4$
	$w = (W : 2 + 26) : 2$

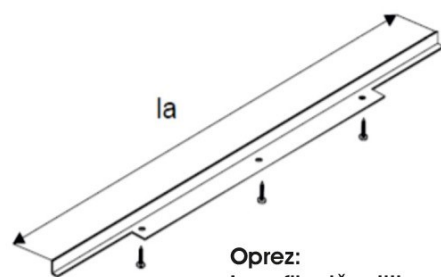
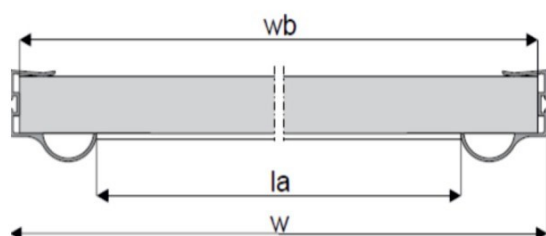

Oprez:
L profil pričvrstiti sa najmanje 3 vijka 3x25!

PAŽNJA

Ručnica treba biti duža od visine ispune za 2 mm!

VAŽNO

Sevroll ne preuzima odgovornost za deformacije vrata, koje uzrokuje pogrešna montaža ili nekvalitetna ispuna!

SIMPLE START



- jednostavno rješenje za klizna vrata bez okvira
- MAX nosivost 50KG
- podesivo po visini ± 5 mm
- dužine vodilica 2m i 3m
- zaustavljivači za donje ležajeve

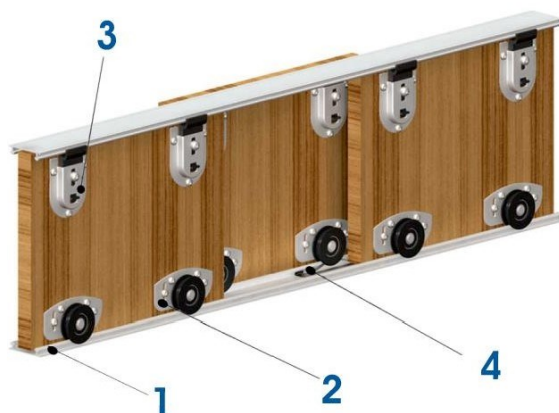

1

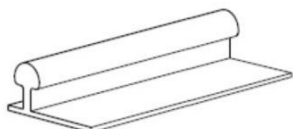

šifra	naziv	JM
SVSSV2	Sevroll Simple Start vodilica 2000 sir.ALU	KOM
SVSSV3	Sevroll Simple Start vodilica 3000 sir.ALU	KOM

2

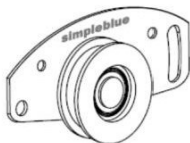

šifra	naziv	JM
SVSSDL	Sevroll Simple Start donji ležaj	KOM

3

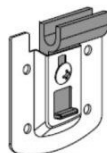

šifra	naziv	JM
SVSSGL	Sevroll Simple Start gornji ležaj	KOM

4



šifra	naziv	JM
SVSSZ	Sevroll Simple Start zaustavljivač	KOM



SIMPLE START

SEVROLL

UPUTE ZA MONTAŽU:

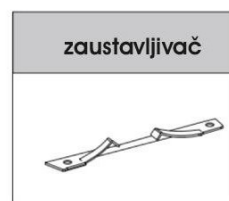
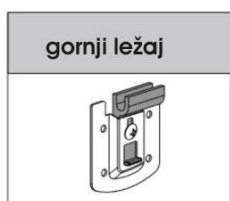
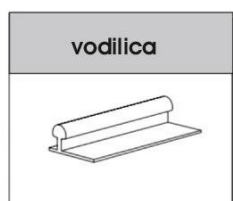
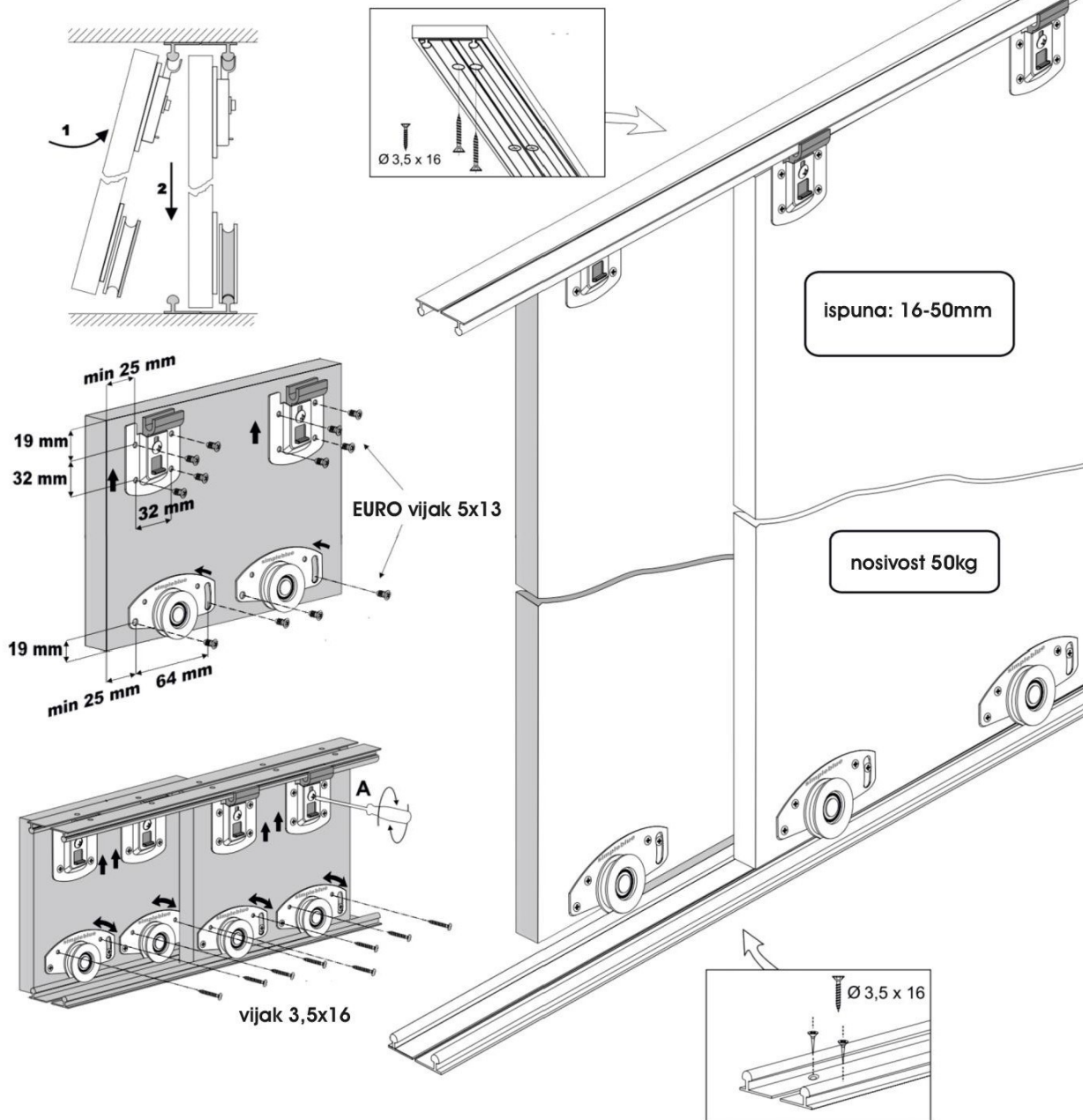

SIMPLE START

dimezije svijetlog otvora

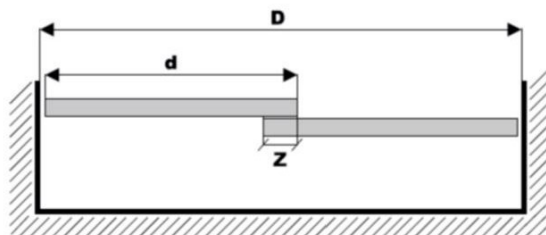
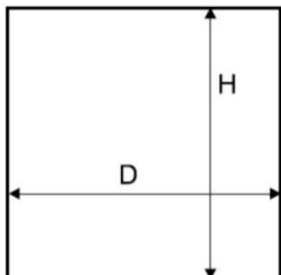

visina vrata - h	$h = H - 13 \text{ mm}$
širina vrata - d	$d = (D + Z) : N$

broj vrata - N	2	3
ukupno preklapa - Z	40 mm	80 mm

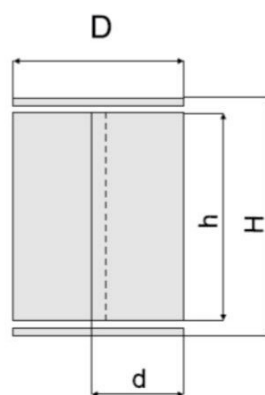

primjer izračuna različitih preklapanja:	
	$d = (D + 120) : 4$
	$d = (D : 2 + 40) : 2$

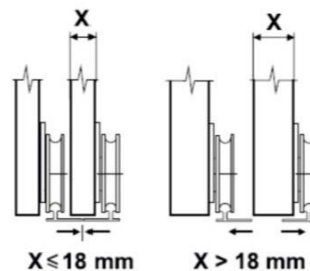

montaža stopera:

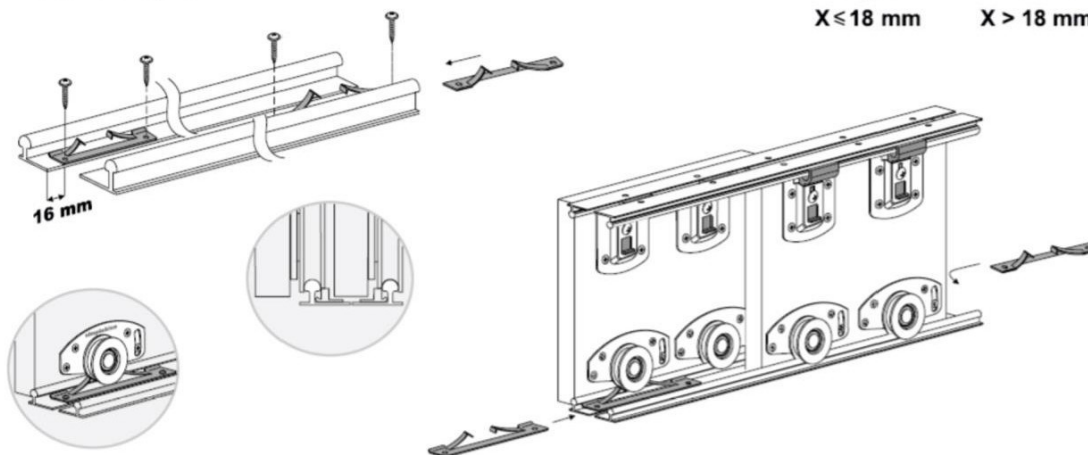



SIMPLE 18 GALAXY



SEVROLL

- jednostavno rješenje za pregradna vrata bez donje vodilice
- MAX nosivost 50KG
- podesivo po visini
- dužine vodilica 2,5m
- zaustavljači/stoperi, ALU maska pokriva vodilicu

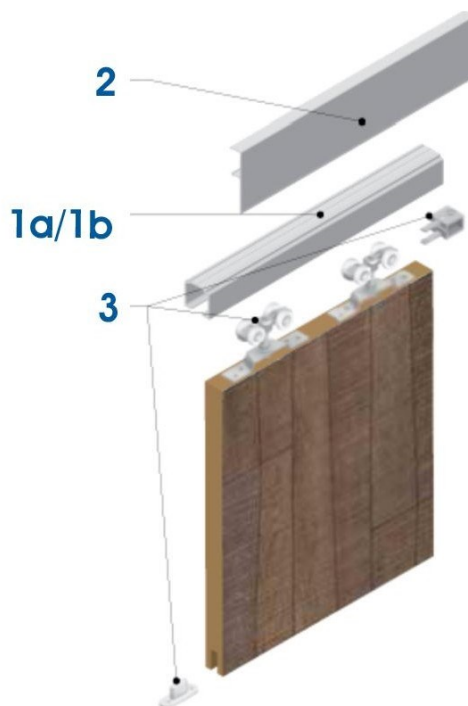

1a

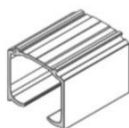

šifra	naziv	JM
SVS18GVU	Sevroll S18 gornja vodilica U 2500mm sirALU	KOM

1b

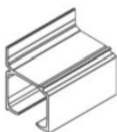

šifra	naziv	JM
SVS18GVh	Sevroll S18 gornja vodilica h 2500mm sirALU	KOM

2



šifra	naziv	JM
SVS18MV	Sevroll S18 maska za vodilicu 2500mm ALU	KOM

3

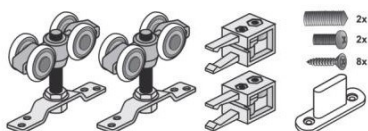

šifra	naziv	JM
SVS18SL	Sevroll S18 set ležajeva	KOM

SIMPLE 18 GALAXY

stoper (1) postavite u vodlicu na poziciju (2) i učvrstite vijkom A, a silu (3) podesite vijkom B

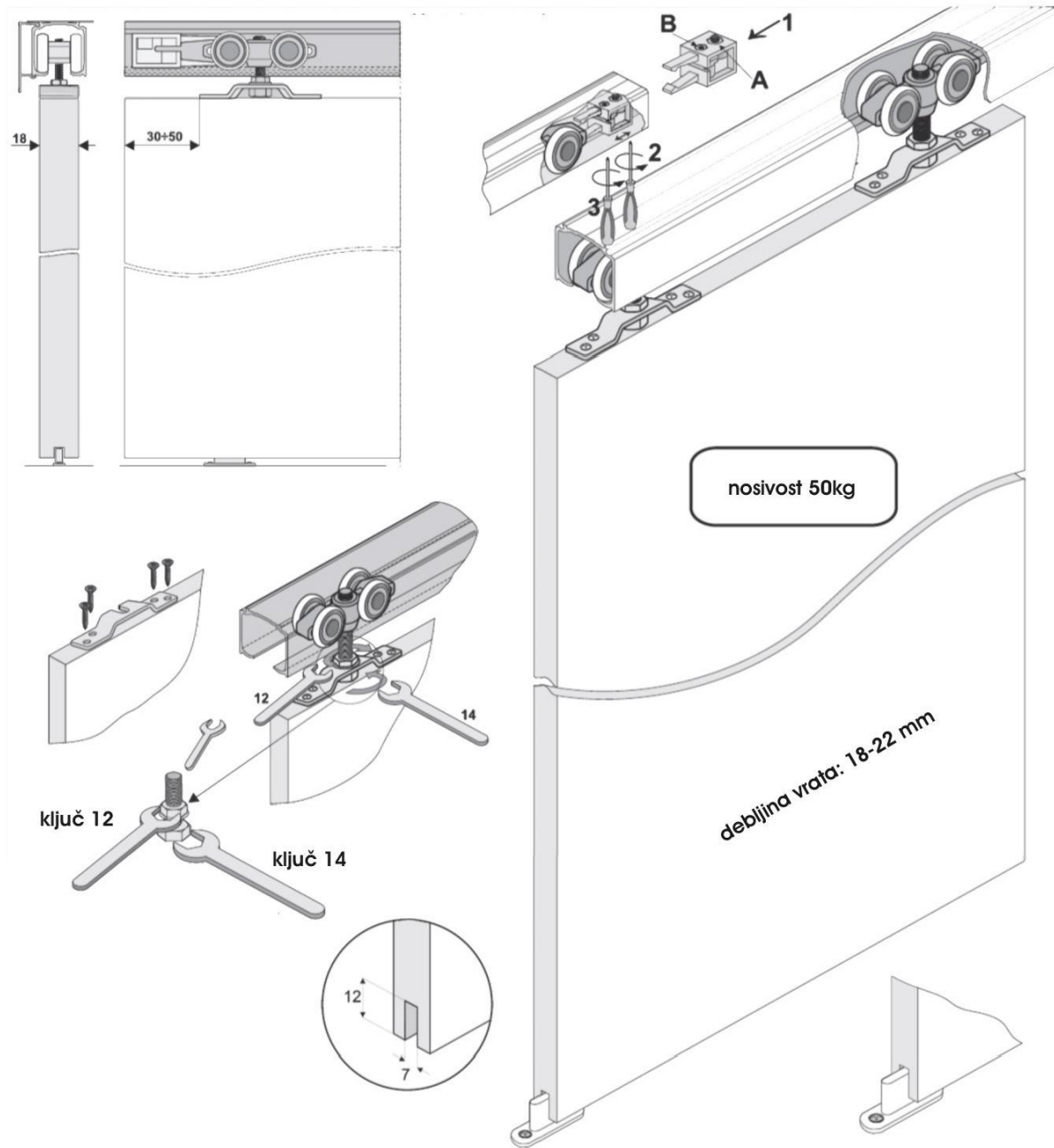

KOMPONENTE





vrata u svijetlom otvoru

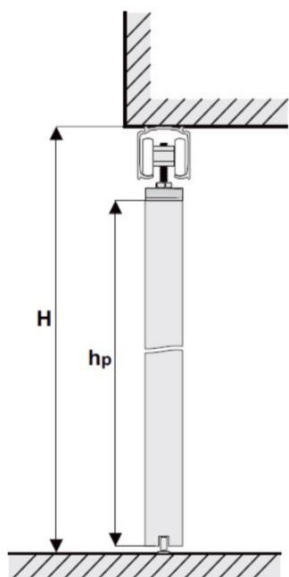

visina ispune = h_p

$$h_p = H - 65 \text{ mm}$$

H - visina svijetlog otvora

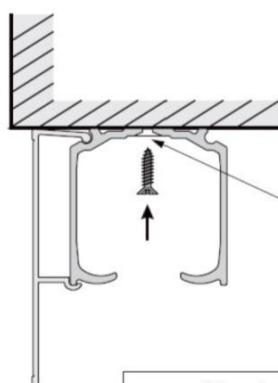

montaža gornje vodilice U
(potrebno upustiti rupe kako
glava vijka ne bi smetala
ležajevima)

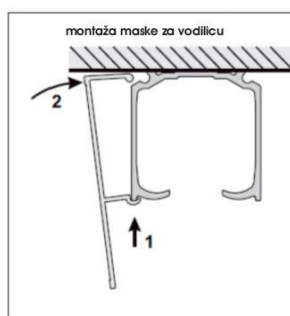

montaža maske za vodilicu

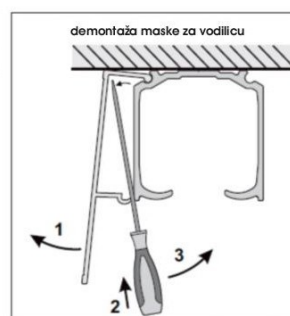

demontaža maske za vodilicu

vrata izvan svijetlog otvora

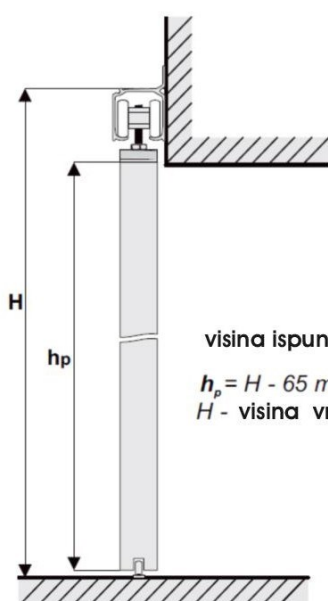

visina ispune = h_p

$$h_p = H - 65 \text{ mm}$$

H - visina vrata sa vodilicom

montaža gornje vodilice h

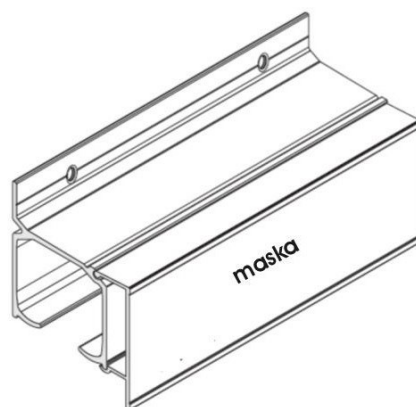
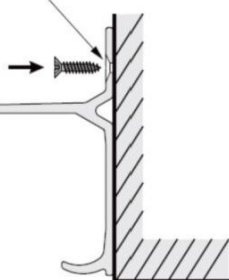

VAŽNO

Vodilicu pričvrstite prije postavljanja vrata kako bi izbjegli uvijanje iste!



studio
drvodom

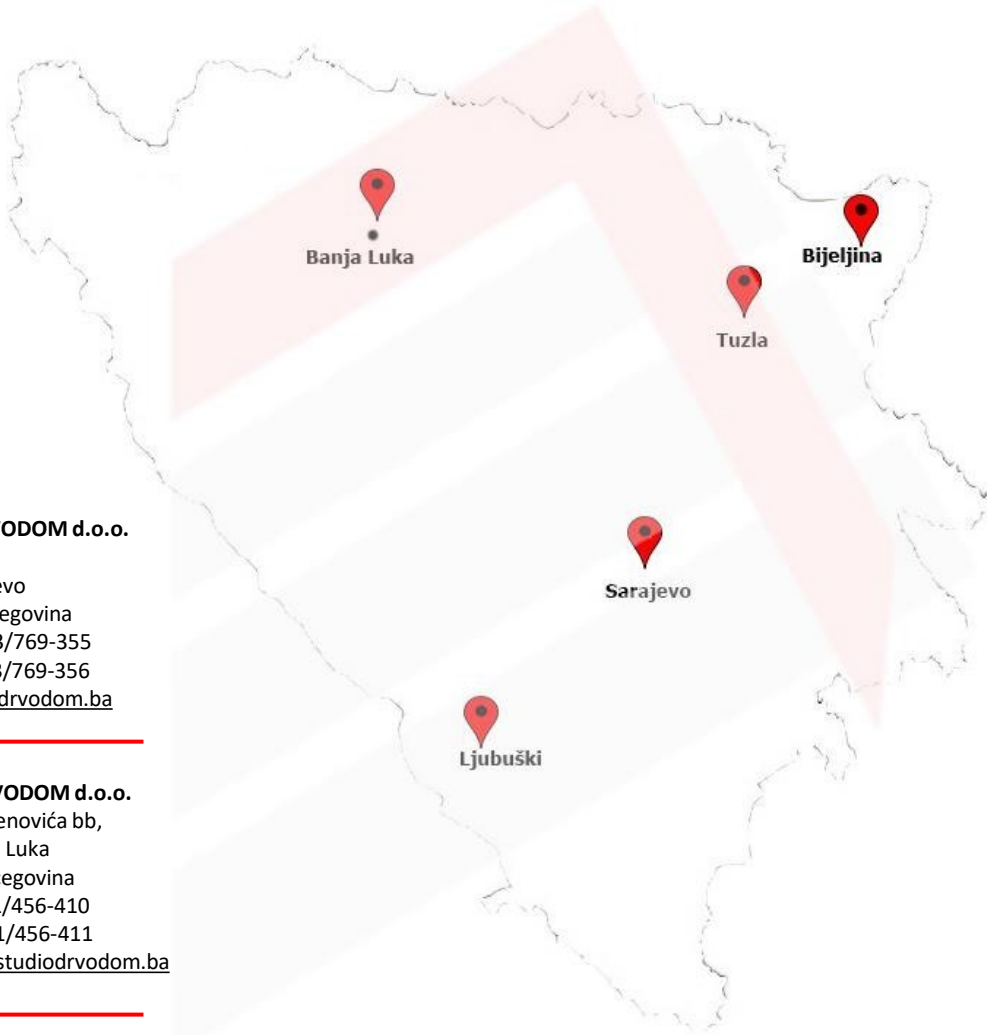

STUDIO DRVODOM d.o.o.

Bačići br. 12,
71000 Sarajevo
Bosna i Hercegovina
Tel: +387/33/769-355
Fax: +387/33/769-356
info@studiodrvodom.ba

STUDIO DRVODOM d.o.o.

Veljka Mladenovića bb,
78000 Banja Luka
Bosna i Hercegovina
Tel: +387/51/456-410
Fax: +387/51/456-411
banjaluka@studiodrvodom.ba

STUDIO DRVODOM d.o.o.

Magistralni put bb,
75300 Lukavac
Bosna i Hercegovina
Tel: +387/35/541-399
Fax: +387/35/541-398
tuzla@studiodrvodom.ba



studio
drvodom d.o.o.

www.studiodrvodom.ba